

WIDEBAND POWER AMPLIFIER MODULE, 21 - 31 GHz



Typical Applications

The HMC-C020 Wideband PA is ideal for:

- Microwave Radio & VSAT
- Military & Space
- Test & Lab Instrumentation

Functional Diagram

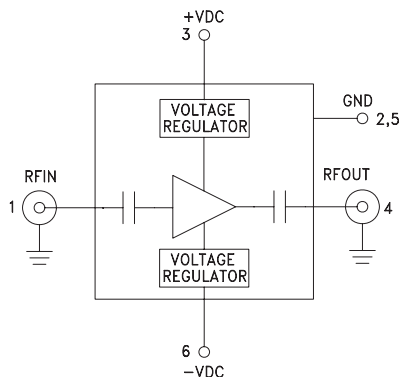

Features

- Gain: 15 dB @ 27 GHz
- P1dB Output Power: +24 dBm @ 27 GHz
- Noise Figure: 5 dB @ 27 GHz
- Spurious-Free Operation
- Regulated Supply and Bias Sequencing
- Hermetically Sealed Module
- Field Replaceable 2.92mm connectors
- 55 to +85°C Operating Temperature

General Description

The HMC-C021 is a GaAs MMIC PHEMT Distributed Power Amplifier in a miniature, hermetic module with replaceable 2.92mm connectors which operates between 21 and 31 GHz. The amplifier provides 15 dB of gain, 5 dB noise figure, +33 dBm output IP3 and up to +24 dBm of output power at 1 dB gain compression. The wideband amplifier I/Os are internally matched to 50 Ohms and are DC blocked making the HMC-C021 ideal for EW, ECM RADAR and test equipment applications. Integrated voltage regulators allow for flexible biasing of both the negative and positive supply pins, while internal bias sequencing circuitry assures robust operation.

Electrical Specifications, $T_A = +25^\circ \text{C}$, +VDC = +8V to +15V, -VDC = -4.5V to -10V*

Parameter	Min.	Typ.	Max.	Min.	Typ.	Max.	Units
Frequency Range	21 - 24		24 - 31				GHz
Gain	13	16	18	12	15	18	dB
Gain Flatness	±0.20		±1.0				dB
Gain Variation Over Temperature	-0.03		-0.04				dB/ °C
Noise Figure	5.0		7.0				dB
Input Return Loss	7		7				dB
Output Return Loss	7		10				dB
Output Power for 1 dB Compression (P1dB)	20	23		20	23		dBm
Saturated Output Power (Psat)	24		24				dBm
Output Third Order Intercept (IP3)	30		34				dBm
Positive Supply Current (+IDC)	215		215				mA
Negative Supply Current (-IDC)	5.8		5.8				mA

* Data recorded at +Vdc = +12V and - Vdc = -5V

For price, delivery, and to place orders, please contact Hittite Microwave Corporation:
20 Alpha Road Chelmsford, MA 01824 Phone: 978-250-3343 Fax: 978-250-3373
Order Online at www.hittite.com

**WIDEBAND POWER AMPLIFIER
MODULE, 21 - 31 GHz**

Gain & Return Loss

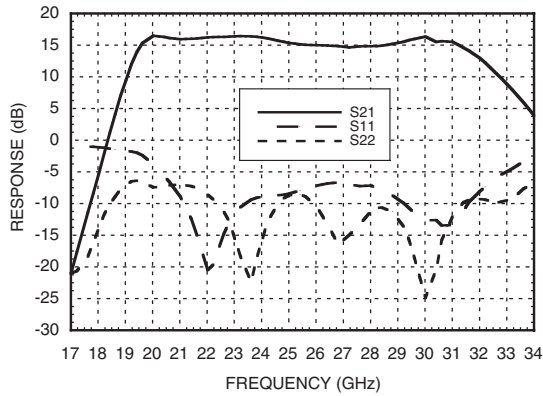

Gain vs. Temperature

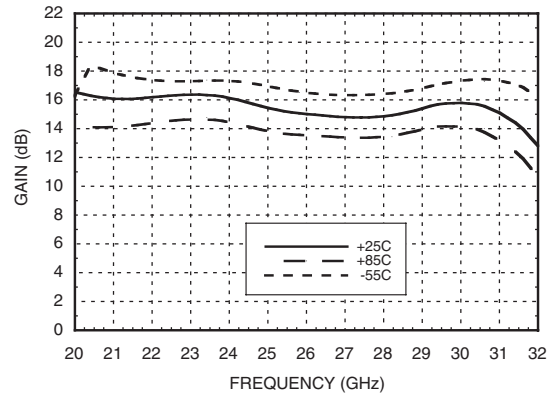

Input Return Loss vs. Temperature

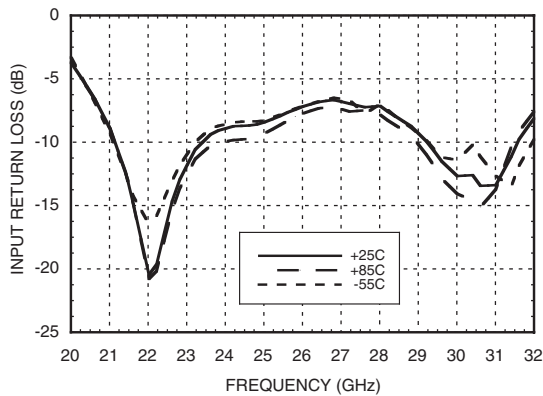

Output Return Loss vs. Temperature

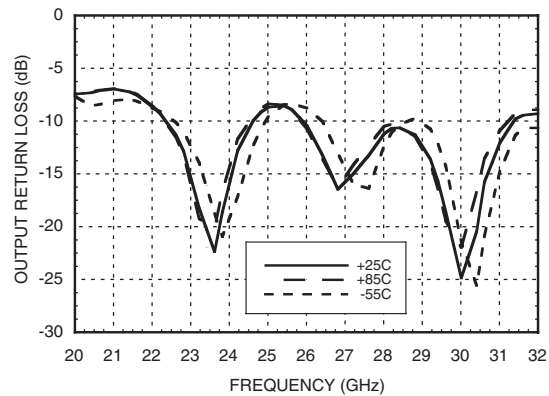

Reverse Isolation vs. Temperature

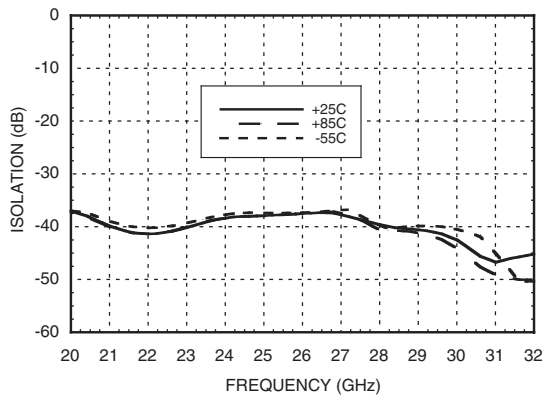

Noise Figure vs. Temperature

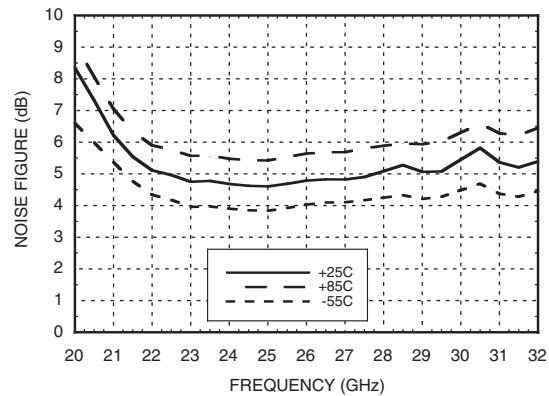

WIDEBAND POWER AMPLIFIER MODULE, 21 - 31 GHz

P1dB vs. Temperature

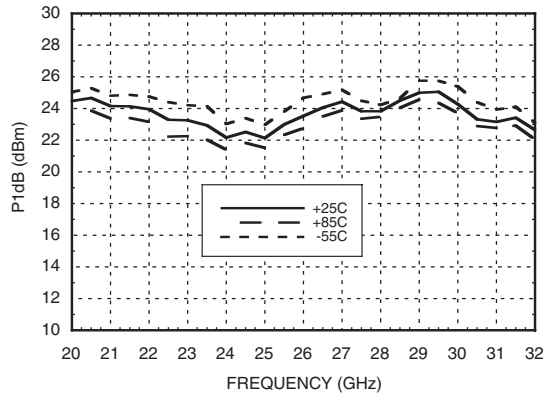

Psat vs. Temperature

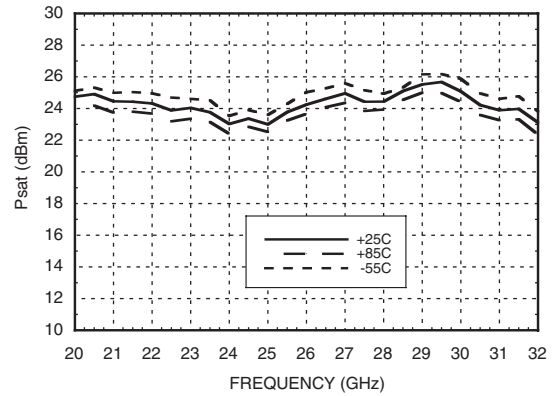

Output IP3 vs. Temperature

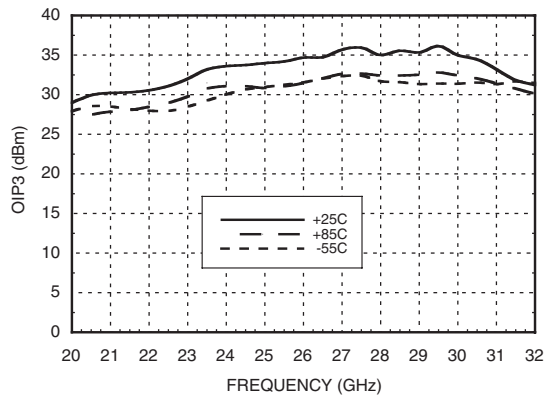

Absolute Maximum Ratings



Positive Bias Supply Voltage (+VDC)	+17V Max
Negative Bias Supply (-VDC)	-16V Min.
RF Input Power (RFIn)	+20 dBm
Storage Temperature	-65 to +150 °C
Operating Temperature	-55 to +85 °C



**ELECTROSTATIC SENSITIVE DEVICE
OBSERVE HANDLING PRECAUTIONS**

**WIDEBAND POWER AMPLIFIER
MODULE, 21 - 31 GHz**

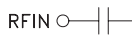
Pin Descriptions

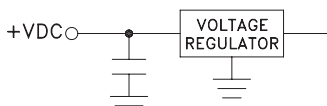
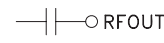
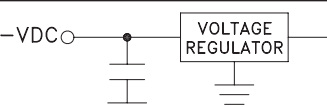
Pin Number	Function	Description	Interface Schematic
1	RFIN	RF input connector, 2.92mm female, field replaceable. This pin is AC coupled and matched to 50 Ohms from 21 - 31 GHz.	
2, 5	GND	Power supply ground.	
3	+VDC	Positive power supply voltage for the amplifier.	
4	RFOUT	RF output connector, 2.92mm female. This pin is AC coupled and matched to 50 Ohms from 21 - 31 GHz.	
6	-VDC	Negative power supply voltage for the amplifier	

WIDEBAND POWER AMPLIFIER MODULE, 21 - 31 GHz

Outline Drawing

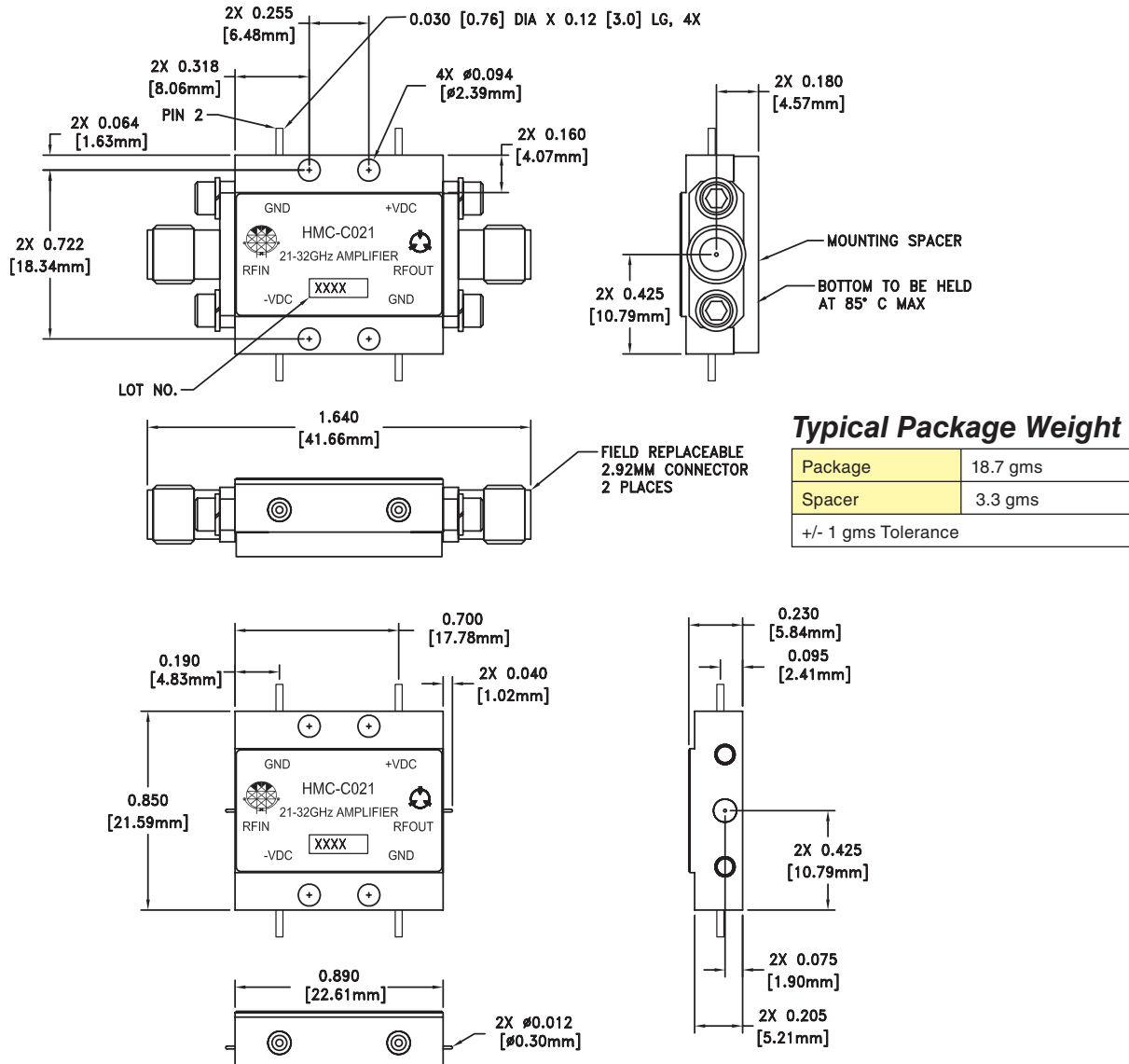

Typical Package Weight

Package	18.7 gms
Spacer	3.3 gms
+/- 1 gms Tolerance	

NOTES:

1. PACKAGE, LEADS, COVER MATERIAL: KOVAR™
2. PLATING: ELECTROLYTIC GOLD 50 MICROINCHES MIN., OVER ELECTROLYTIC NICKEL 75 MICROINCHES MIN.
3. SPACER MATERIAL: NICKEL PLATED ALUMINUM
4. ALL DIMENSIONS ARE IN INCHES [MILLIMETERS].
5. TOLERANCES \pm 0.010 [0.25] UNLESS OTHERWISE SPECIFIED.
6. FIELD REPLACEABLE 2.92MM CONNECTORS.

**WIDEBAND POWER AMPLIFIER
MODULE, 21 - 31 GHz**

Notes: